



polycon
surface water drainage

SF 300

Installation Guide

Service . Range . Knowledge

Installation Guide

Ground conditions must be suitable and all dimensions shown are the minimum requirement. Engineering advice should be taken where necessary and any questions should be directed to Polycon's technical team by emailing us at sales@polycon.co.uk or by calling us on **0151 424 9747**.

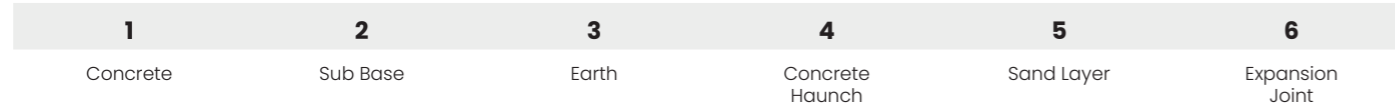

Block Paving

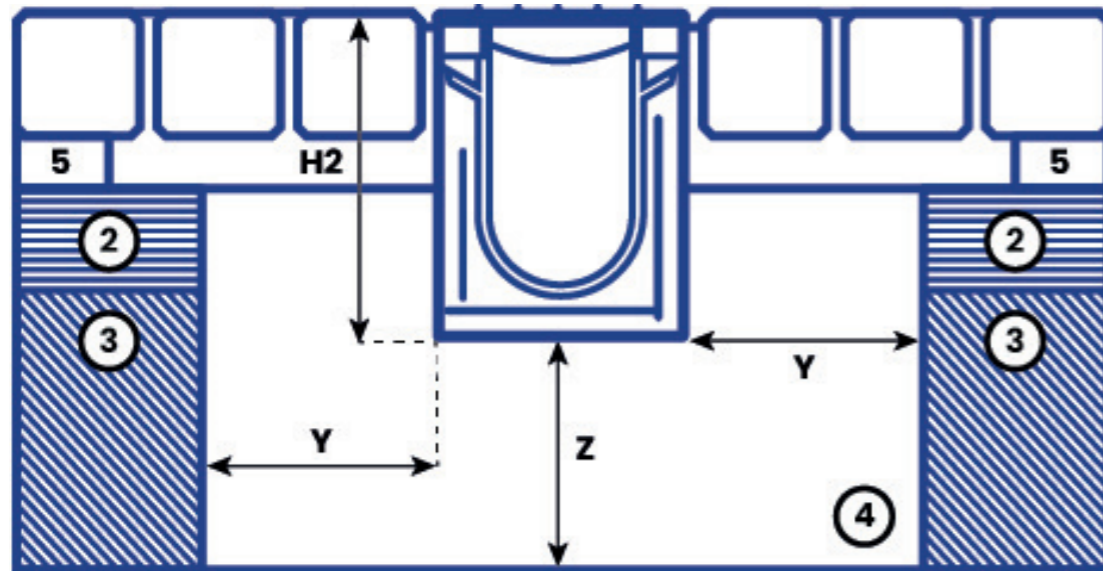

Tarmac

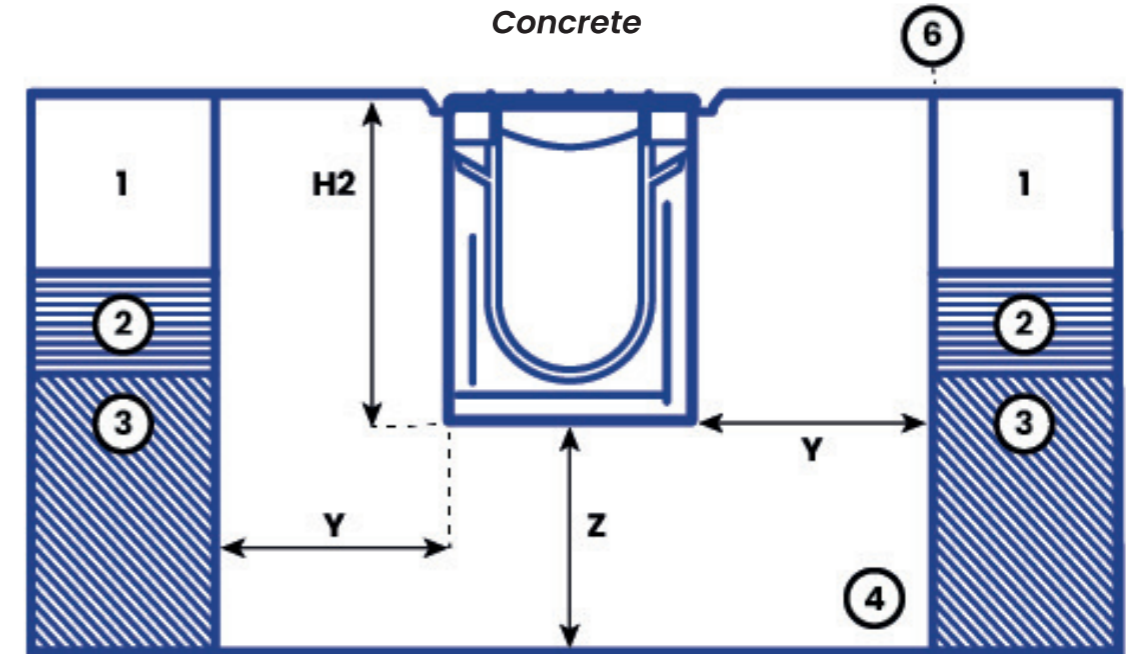
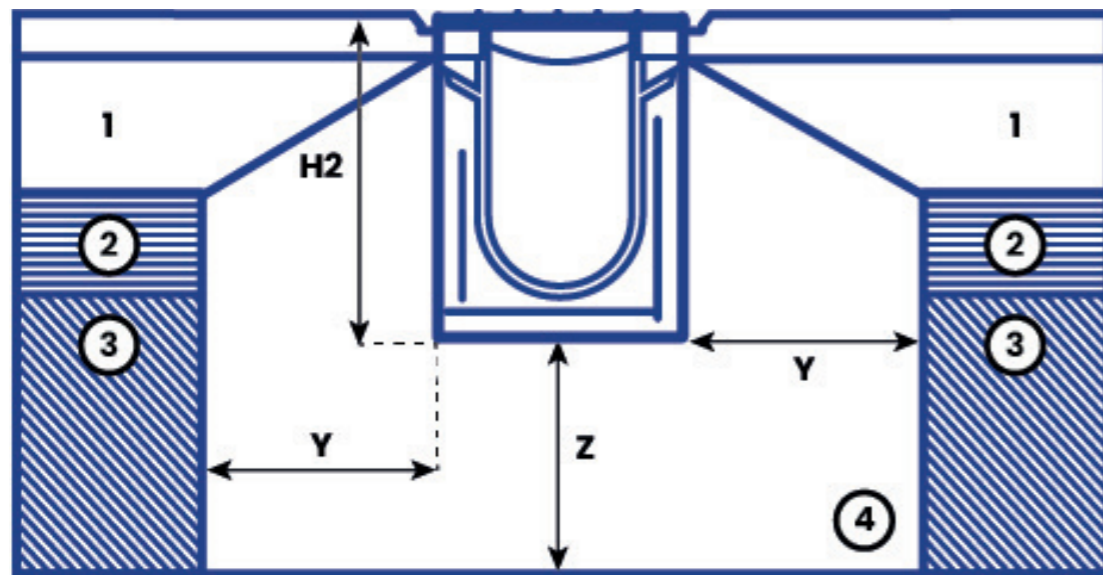

Load Class	A15	B125	C250	D400	E600	F900
H2 - Channel Height	Channel Height	Channel Height	Channel Height	Channel Height	Channel Height	Channel Height
Y - Minimum Surround	100mm	150mm	150mm	200mm	200mm	250mm
Z - Minimum Surround	100mm	150mm	150mm	200mm	200mm	250mm
T1 - Minimum Depth	40mm	40mm	40mm	40mm	40mm	40mm
T2 - Maximum Depth	95mm	55mm	55mm	55mm	55mm	55mm

** Minimum Concrete Haunch 25 N/mm².
Detail A allow for overbuild of 3mm to 5mm above the grating surfaces.





Polycon Surface Water Drainage

**Widnes Business Park
Foundry Lane
Widnes
Cheshire
WA8 8UB**

**www.polycon.co.uk
0151 422 9747
sales@polycon.co.uk**

Service . Range . Knowledge