



KE RANGE

Service . Range . Knowledge

Welcome To Polycon

Polycon is identified as one of the leading manufacturers, distributors, and suppliers of channel drainage in the UK. We focus towards creating a diverse range of water solutions, in a variety of different materials, including composite, polymer concrete, SMC, and steel.

Polycon's unique look at the market and expert knowledge of the industry ensures that we can supply a wide range of high-quality products suitable for any application. This includes building drainage, landscaping, sports facilities, distribution centres, highways, and airports.

Our design team provides innovative and efficient hydraulic solutions to ensure we can offer the best product/ solution for your drainage needs. We have a vast and experienced overview of our working industry and have been manufacturing, distributing, and selling channel drainage for over 8 years. We thrive on acting upon your feedback to improve and develop our products to fit flawlessly with the constantly changing market and demand from our customers.

At Polycon we focus our attention on professionals who sit within the construction industry, targeting our products to specifiers, architects, engineers, and contractors. Therefore, we understand the importance of expanding our product portfolio to create the most efficient surface water drainage systems.

We are a dynamic and evolving company with a focus on quality, innovation, and service. As a result, you can rely on us to handle your project needs in every way to the best of our ability.

Contents

<i>KE 100</i>	<i>3</i>
<i>KE 150</i>	<i>15</i>
<i>KE 200</i>	<i>27</i>
<i>Sloped, Stepped, Level</i>	<i>39</i>

KE100

KE 100

The KE 100 channel is a versatile and innovative drainage solution that offers a multitude of advantages in construction and civil engineering projects. At the heart of its design lies the exceptional combination of a galvanized or stainless-steel edge rail and a core made from polymer concrete. This unique blend of materials results in a drainage channel that not only excels in durability but also offers a range of practical benefits that make it a popular choice for a wide array of applications.

The incorporation of galvanized or stainless-steel edge rails within the KE 100 channel is a standout feature. This steel component enhances the product's strength and longevity, ensuring that it can withstand traffic loads and harsh environmental conditions.

The corrosion-resistant properties of these materials make the KE 100 channel an excellent choice for projects where extended service life and minimal maintenance are essential. Furthermore, the steel edge rail provides crucial structural support to the entire drainage system, preventing deformation and ensuring efficient water conveyance.

The core of the KE 100 channel is constructed from polymer concrete, which offers several advantages in terms of durability and performance. This material is highly resistant to chemical and physical wear, making it an ideal choice for applications in industrial and commercial settings where exposure to corrosive substances is a concern. Additionally, the polymer concrete core is lightweight, facilitating easier handling and installation, while also promoting a reduction in transportation costs.

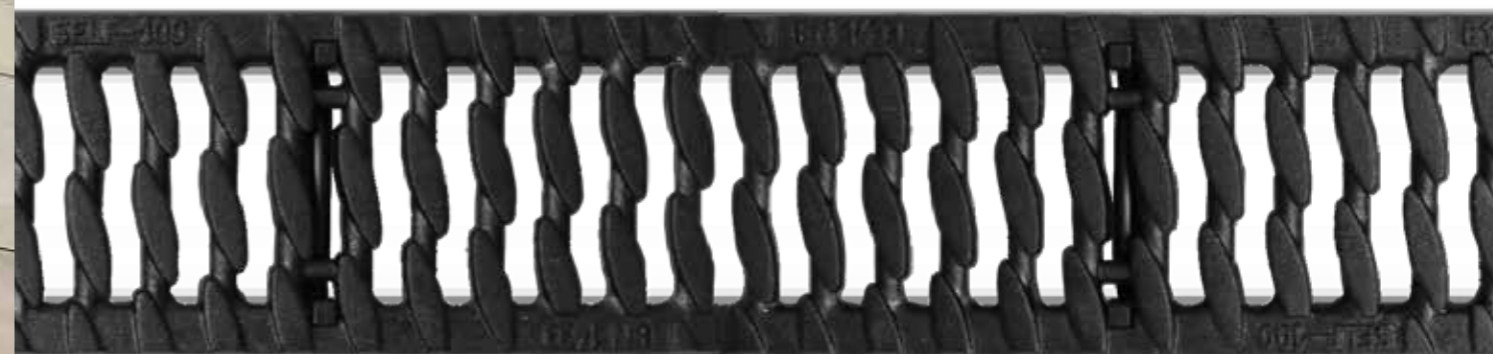

Load Class

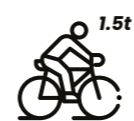

1.5t
A15
1.5 tonnes



12.5t
B125
12.5 tonnes



25t
C250
25 tonnes



40t
D400
40 tonnes

Applications

- Driveways
- Car parks
- Farms
- Commercial & civil areas

KE 100 - Overview

Colour Options

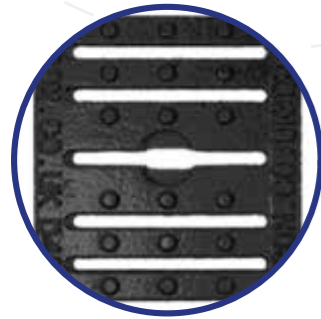

Grating Options

The KE 100 channel offers a remarkable variety of 10 different grating options, allowing for customized solutions tailored to specific project requirements. These grating choices encompass a wide spectrum of designs, materials, and load-bearing capacities, ensuring adaptability to diverse applications. These grates can be crafted from materials like galvanized or stainless steel, ductile iron, and composite materials, offering exceptional resistance to corrosion, exceptional load-bearing capabilities, and enhanced aesthetic appeal.

Bolt & Bar

Bolt & Bar fastenings are optimised for the specific load classes and unite reliability and high quality with functional design.

Black Edge Rail

This system is also available in black cataphoretic dip coating.

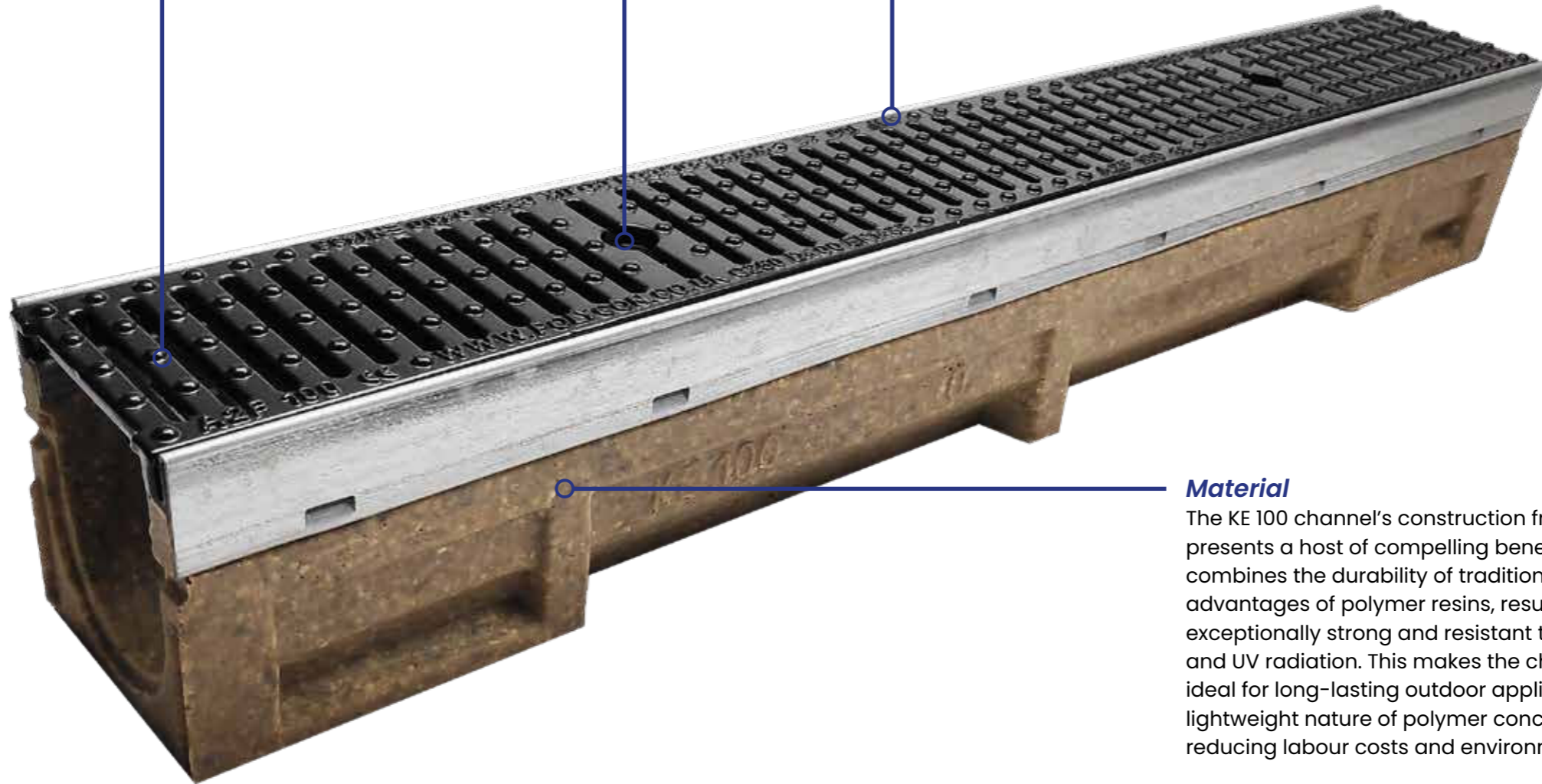

Material

The KE 100 channel's construction from polymer concrete presents a host of compelling benefits. Polymer concrete combines the durability of traditional concrete with the added advantages of polymer resins, resulting in a material that is exceptionally strong and resistant to corrosion, chemicals, and UV radiation. This makes the channel highly durable and ideal for long-lasting outdoor applications. Furthermore, the lightweight nature of polymer concrete simplifies installation, reducing labour costs and environmental impact.

Load Classes



1.5t

A15



12.5t

B125

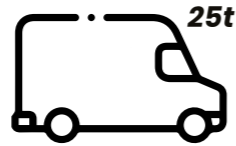

25t

C250

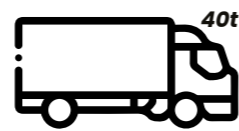

40t

D400

Depth Options



60mm



80mm



100mm



150mm



200mm



250mm

KE 100

The KE 100 channel's combination of a galvanised or stainless-steel edge rail and a polymer concrete core results in a robust and long-lasting drainage solution. Its superior durability, resistance to corrosion, and ease of installation make it a preferred choice for a wide range of construction and civil engineering projects, ensuring effective and sustainable water management.

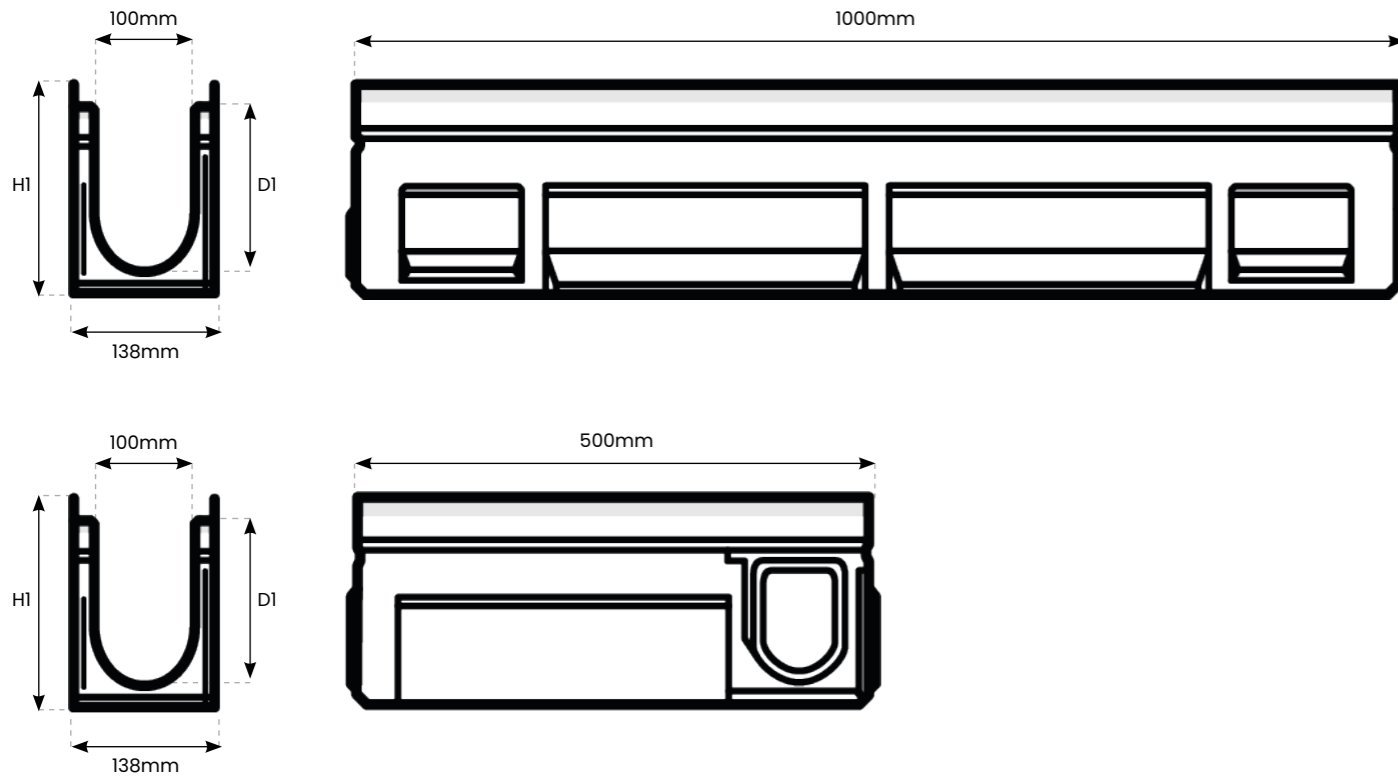

Channel Properties

Polymer concrete:	Polyester resin-based with mineral aggregates, additives.
Compressive strength:	> 90 N/mm ²
Bending tensile strength:	> 22 N/mm ²
Modulus of elasticity:	ca. 25 kN/mm ²
Density:	2.1 - 2.3 g/dm ³
Heat resistance:	100°C (permanant loading)
Frost resistance:	-50°C
Water penetration depth:	0mm
Water absorption	0.05%
Edge protection:	Galvanised steel, stainless steel, profile thickness 6mm or cataphoretic black.
Channel cover:	Galvanised steel, V2A stainless steel, GJS cast-iron, PA plastic.

Channel Types

Reference	Description	Slope	Length	Overall Width	Internal Width	Overall Depth(H1)	Internal Depth(D1)	Weight
KE.100.0	KE - 100 Channel No. 0*	0%	1000mm	138mm	100mm	150mm	130mm	17.5kg
KE.100.0R	KE - 100 Channel No. 0R***	0%	1000mm	138mm	100mm	150mm	130mm	17.5kg
KE.100.005	KE - 100 Channel No. 005**/*	0%	500mm	138mm	100mm	150mm	130mm	9.5kg
KE.100.1	KE - 100 Channel No. 1	0.5%	1000mm	138mm	100mm	155mm	135mm	17.5kg
KE.100.2	KE - 100 Channel No. 2	0.5%	1000mm	138mm	100mm	160mm	140mm	17.5kg
KE.100.3	KE - 100 Channel No. 3	0.5%	1000mm	138mm	100mm	165mm	145mm	18kg
KE.100.4	KE - 100 Channel No. 4	0.5%	1000mm	138mm	100mm	170mm	150mm	18kg
KE.100.5	KE - 100 Channel No. 5*	0.5%	1000mm	138mm	100mm	175mm	155mm	18.5kg
KE.100.055	KE - 100 Channel No. 05R***	0%	1000mm	138mm	100mm	175mm	155mm	18.5kg
KE.100.6	KE - 100 Channel No. 055**/*	0%	500mm	138mm	100mm	175mm	155mm	9.5kg
KE.100.6	KE - 100 Channel No. 6	0.5%	1000mm	138mm	100mm	180mm	160mm	19kg
KE.100.7	KE - 100 Channel No. 7	0.5%	1000mm	138mm	100mm	185mm	165mm	19.5kg
KE.100.8	KE - 100 Channel No. 8	0.5%	1000mm	138mm	100mm	190mm	170mm	19.5kg
KE.100.9	KE - 100 Channel No. 9	0.5%	1000mm	138mm	100mm	195mm	175mm	20kg
KE.100.10	KE - 100 Channel No. 10*	0.5%	1000mm	138mm	100mm	200mm	180mm	21kg
KE.100.010	KE - 100 Channel No. 010*	0%	1000mm	138mm	100mm	200mm	180mm	21kg
KE.100.010R	KE - 100 Channel No. 010R*	0%	1000mm	138mm	100mm	200mm	180mm	21kg
KE.100.0105	KE - 100 Channel No. 0105**/*	0%	500mm	138mm	100mm	200mm	180mm	10.5kg
KE.100.11	KE - 100 Channel No. 11	0.5%	1000mm	138mm	100mm	205mm	185mm	20.5kg
KE.100.12	KE - 100 Channel No. 12	0.5%	1000mm	138mm	100mm	210mm	190mm	21kg
KE.100.13	KE - 100 Channel No. 13	0.5%	1000mm	138mm	100mm	215mm	195mm	21.5kg
KE.100.14	KE - 100 Channel No. 14	0.5%	1000mm	138mm	100mm	215mm	195mm	22kg
KE.100.15	KE - 100 Channel No. 15*	0.5%	1000mm	138mm	100mm	220mm	200mm	22.5kg
KE.100.16	KE - 100 Channel No. 16	0.5%	1000mm	138mm	100mm	225mm	205mm	23kg
KE.100.17	KE - 100 Channel No. 17	0.5%	1000mm	138mm	100mm	230mm	210mm	23kg
KE.100.18	KE - 100 Channel No. 18	0.5%	1000mm	138mm	100mm	235mm	215mm	23.5kg
KE.100.19	KE - 100 Channel No. 19	0.5%	1000mm	138mm	100mm	240mm	220mm	24kg
KE.100.20	KE - 100 Channel No. 20*	0.5%	1000mm	138mm	100mm	245mm	225mm	24.5kg
KE.100.020	KE - 100 Channel No. 020*	0%	1000mm	138mm	100mm	250mm	230mm	25.5kg
KE.100.020R	KE - 100 Channel No. 020R*	0%	1000mm	138mm	100mm	250mm	230mm	25.5kg
KE.100.0205	KE - 100 Channel No. 0205**/*	0%	500mm	138mm	100mm	250mm	230mm	11.2kg
KE.100.060	KE - 100 Channel No. 060*	0%	1000mm	138mm	100mm	60mm	40mm	13.1kg
KE.100.060R	KE - 100 Channel No. 060R***	0%	1000mm	138mm	100mm	60mm	40mm	13.1kg
KE.100.080	KE - 100 Channel No. 080*	0%	1000mm	138mm	100mm	80mm	60mm	13.3kg
KE.100.080R	KE - 100 Channel No. 080R*	0%	1000mm	138mm	100mm	80mm	60mm	13.3kg
KE.100.0100	KE - 100 Channel No. 0100*	0%	1000mm	138mm	100mm	100mm	80mm	14.4kg
KE.100.0100R	KE - 100 Channel No. 0100R*	0%	1000mm	138mm	100mm	100mm	80mm	14.4kg

* Channel with mouldings for vertical outlet DA/OD 110.

** Channel with sidewise perforations for the connection of t-junctions, elbow joints and cross-over joints and vertical outlet.

*** Channel with vertical pipe socket DA/OD 110.

Accessories

Sump Unit

Sump Units act as a reservoir, temporarily storing excess water before discharging it in a controlled manner to prevent adverse effects of water accumulation. The Sump Unit is excellent for collecting debris and waste that can get into the system. It comes with a silt bucket inside for easy cleaning.



Sump Unit

End Cap

End Caps can be used at the end of your channel run to stop the flow of water.



End Cap

End Cap Outlet

The End Cap Outlet can be used at the end of the run to allow water to be taken to your exterior drainage pipes and away from the channel.



End Cap Outlet

Access Tray

Access trays are typically used for maintenance and inspection purposes, they are installed at strategic points along the channel, often at intervals where they can be easily reached for cleaning, inspection, or repairs.



Access Tray

Accessories- Specifications

Reference	Description	Length	Height (H)	Overall Width	Slot Width	Weight (KG)	Outlet
KE.100.SU	KE 100 Sump Unit	500mm	450mm	140mm	-	14.8kg	110mm
KE.100.DSU	KE 100 Deep Sump Unit	500mm	585mm	140mm	-	21.8kg	110mm
KE.100.EC	KE 100 End Cap for channel No. 0 - 0205	30mm	150-250mm	140mm	-	0.6kg	-
KE.100.ECO	KE 100 End Cap Outlet	30mm	160mm	140mm	-	0.7kg	110mm
KE.100.AT.G	KE 100 Access Tray - Galvanised	500mm	105mm	123mm	10mm	6.5kg	-
KE.100.AT.SS	KE 100 Access Tray - Stainless Street	500mm	105mm	123mm	10mm	6.5kg	-

Grating Options



Slotted Steel Grating (C250)

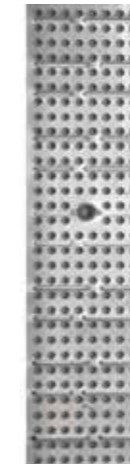

Perforated Steel Grating (C250)



Mesh Steel Grating (C250)



Composite Slotted Grating (A15)



Composite Mesh Grating (B125)



Composite Oval Grating (C250)



Ductile Iron Slotted Grating (D400)



Ductile Iron Longitudinal Grating (D400)



Ductile Iron Narrow Slotted Grating (D400)



Ductile Iron Oval Grating (E600)

Grating - Specifications

Reference	Description	Lengths (mm)	Overall Width	Weight	Load Class	Safe Heel
KE.100.SSG	KE 100 Slotted Steel Grating	500/1000	123mm	2.4kg	A/C	Yes
KE.100.SSPG	KE 100 Slotted Steel Perforated Grating	500/1000	123mm	1.9kg	A/C	Yes
KE.100.MSG	KE 100 Mesh Steel Grating	500/1000	123mm	3kg	B/C	No
KE.100.CSG	KE 100 Composite Slotted Grating	500/1000	123mm	1.9kg	A	Yes
KE.100.COG	KE 100 Composite Oval Grating	500/1000	123mm	2.6kg	C	No
KE.100.CMG	KE 100 Composite Mesh Grating	500	123mm	3kg	B	No
KE.100.DISG	KE 100 Ductile Iron Slotted Grating	500/1000	123mm	2.1kg	D	No
KE.100.DILG	KE 100 Ductile Iron Longitudinal Grating	500/1000	123mm	2kg	D	No
KE.100.DINSG	KE 100 Ductile Iron Narrow Slotted Grating	500/1000	123mm	4.5kg	C/D	Yes
KE.100.DIOG	KE 100 Ductile Iron Oval Grating	500/1000	123mm	5kg	C/D/E	No

KE 100 – Offset Single Paveslot

KE 100 Offset Paveslot is specifically designed for integration into high-quality natural stone and paving surfaces. The discrete inlet slot enables efficient drainage without compromising the ground design. We offer both single & twin slotted Paveslot as well as an access tray for cleaning purposes.

View From Above

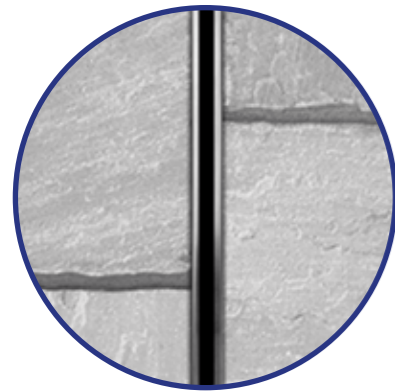

Available In Galvanised and Stainless Steel

Diagram – Offset Single Paveslot

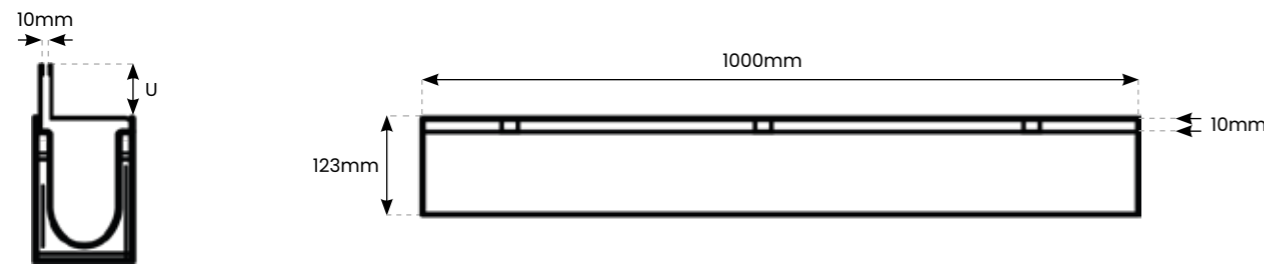

Reference	Description	Length (mm)	Slot Width	Overall Width	Load Class	Upstand (U)
OS.10060.P.G	Galvanised Offset Single Paveslot 60mm	500/1000	10mm	123mm	C/D	60mm
OS.10105.P.G	Galvanised Offset Single Paveslot 105mm	500/1000	10mm	123mm	C/D	105mm
OS.10150.P.G	Galvanised Offset Single Paveslot 150mm	500/1000	10mm	123mm	C/D	150mm
OS.10060.P.SS	Stainless Steel Offset Single Paveslot 60mm	500/1000	10mm	123mm	C/D	60mm
OS.10105.P.SS	Stainless Steel Offset Single Paveslot 105mm	500/1000	10mm	123mm	C/D	105mm
OS.10150.P.SS	Stainless Steel Offset Single Paveslot 150mm	500/1000	10mm	123mm	C/D	150mm

KE 100 – Offset Twin Paveslot

KE 100 Offset Paveslot is specifically designed for integration into high-quality natural stone and paving surfaces. The discrete inlet slot enables efficient drainage without compromising the ground design. We offer both single & twin slotted Paveslot as well as an access tray for cleaning purposes.

View From Above

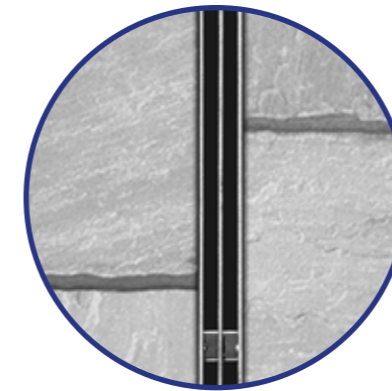

Available In Galvanised and Stainless Steel

Diagram – Offset Twin Paveslot

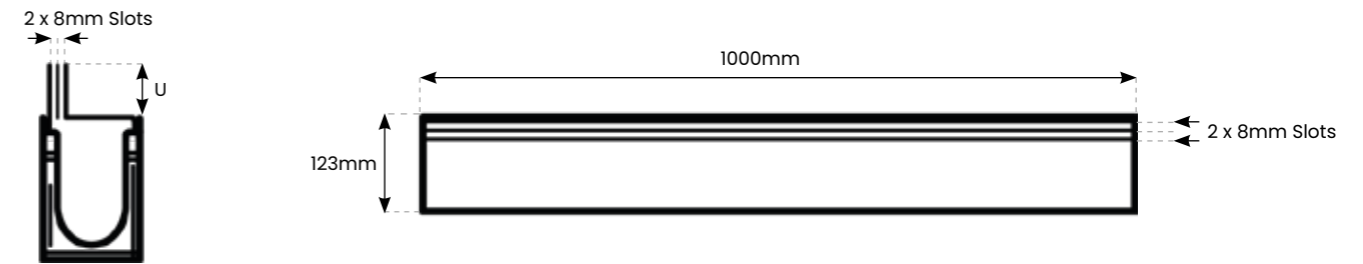

Reference	Description	Length (mm)	Slot Width	Overall Width	Load Class	Upstand (U)
OT.10060.P.G	Galvanised Offset Twin Paveslot 60mm	500/1000	2x8mm	123mm	C/D	60mm
OT.10105.P.G	Galvanised Offset Twin Paveslot 105mm	500/1000	2x8mm	123mm	C/D	105mm
OT.10150.P.G	Galvanised Offset Twin Paveslot 150mm	500/1000	2x8mm	123mm	C/D	150mm
OT.10060.P.SS	Stainless Steel Offset Twin Paveslot 60mm	500/1000	2x8mm	123mm	C/D	60mm
OT.10105.P.SS	Stainless Steel Offset Twin Paveslot 105mm	500/1000	2x8mm	123mm	C/D	105mm
OT.10150.P.SS	Stainless Steel Offset Twin Paveslot 150mm	500/1000	2x8mm	123mm	C/D	150mm

KE 100 – Centre Single Paveslot

KE 100 Centre Paveslot is specifically designed for integration into high-quality natural stone and paving surfaces. The discrete inlet slot enables efficient drainage without compromising the ground design. We offer both single & twin slotted Paveslot as well as an access tray for cleaning purposes.

View From Above

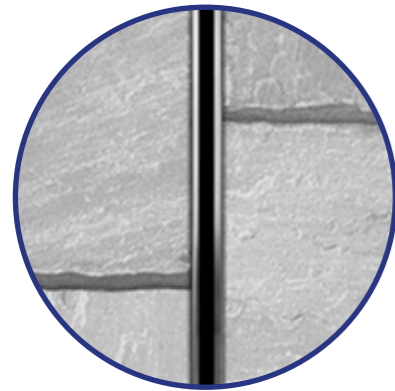

Available In Galvanised and Stainless Steel

Diagram – Centre Single Paveslot

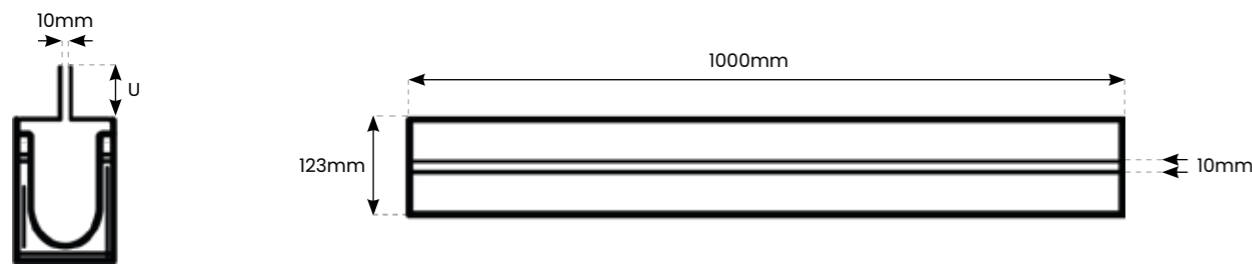

Reference	Description	Length (mm)	Slot Width	Overall Width	Load Class	Upstand (U)
CS.10060.P.G	Galvanised Centre Single Paveslot 60mm	500/1000	10mm	123mm	C/D	60mm
CS.10105.P.G	Galvanised Centre Single Paveslot 105mm	500/1000	10mm	123mm	C/D	105mm
CS.10150.P.G	Galvanised Centre Single Paveslot 150mm	500/1000	10mm	123mm	C/D	150mm
CS.10060.P.SS	Stainless Steel Centre Single Paveslot 60mm	500/1000	10mm	123mm	C/D	60mm
CS.10105.P.SS	Stainless Steel Centre Single Paveslot 105mm	500/1000	10mm	123mm	C/D	105mm
CS.10150.P.SS	Stainless Steel Centre Single Paveslot 150mm	500/1000	10mm	123mm	C/D	150mm

KE 100 – Centre Twin Paveslot

KE 100 Centre Paveslot is specifically designed for integration into high-quality natural stone and paving surfaces. The discrete inlet slot enables efficient drainage without compromising the ground design. We offer both single & twin slotted Paveslot as well as an access tray for cleaning purposes.

View From Above

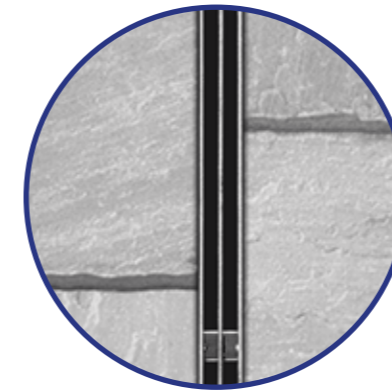

Available In Galvanised and Stainless Steel

Diagram – Centre Twin Paveslot

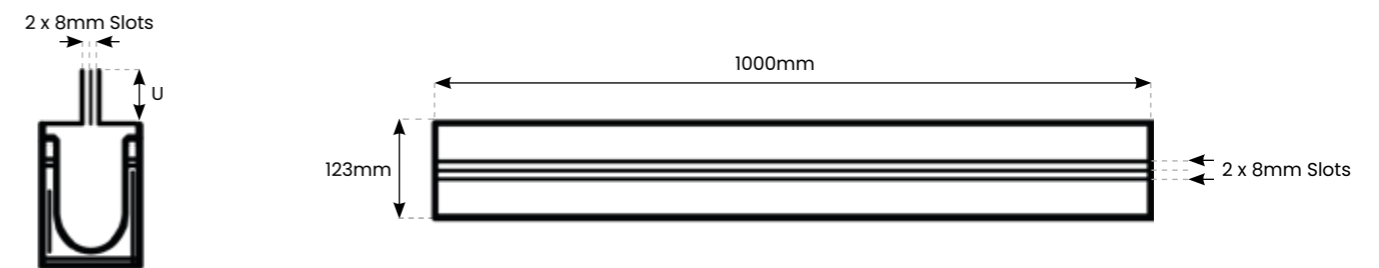

Reference	Description	Length (mm)	Slot Width	Overall Width	Load Class	Upstand (U)
CT.10060.P.G	Galvanised Centre Twin Paveslot 60mm	500/1000	2x8mm	123mm	C/D	60mm
CT.10105.P.G	Galvanised Centre Twin Paveslot 105mm	500/1000	2x8mm	123mm	C/D	105mm
CT.10150.P.G	Galvanised Centre Twin Paveslot 150mm	500/1000	2x8mm	123mm	C/D	150mm
CT.10060.P.SS	Stainless Steel Centre Twin Paveslot 60mm	500/1000	2x8mm	123mm	C/D	60mm
CT.10105.P.SS	Stainless Steel Centre Twin Paveslot 105mm	500/1000	2x8mm	123mm	C/D	105mm
CT.10150.P.SS	Stainless Steel Centre Twin Paveslot 150mm	500/1000	2x8mm	123mm	C/D	150mm

KE 150

KE 150

The KE 150 channel is a versatile and innovative drainage solution that offers a multitude of advantages in construction and civil engineering projects. At the heart of its design lies the exceptional combination of a galvanized or stainless-steel edge rail and a core made from polymer concrete. This unique blend of materials results in a drainage channel that not only excels in durability but also offers a range of practical benefits that make it a popular choice for a wide array of applications.

The incorporation of galvanized or stainless-steel edge rails within the KE 150 channel is a standout feature. This steel component enhances the product's strength and longevity, ensuring that it can withstand traffic loads and harsh environmental conditions.

The corrosion-resistant properties of these materials make the KE 150 channel an excellent choice for projects where extended service life and minimal maintenance are essential. Furthermore, the steel edge rail provides crucial structural support to the entire drainage system, preventing deformation and ensuring efficient water conveyance.

The core of the KE 150 channel is constructed from polymer concrete, which offers several advantages in terms of durability and performance. This material is highly resistant to chemical and physical wear, making it an ideal choice for applications in industrial and commercial settings where exposure to corrosive substances is a concern. Additionally, the polymer concrete core is lightweight, facilitating easier handling and installation, while also promoting a reduction in transportation costs.



Load Class



1.5t

A15
1.5 tonnes



12.5t

B125
12.5 tonnes



25t

C250
25 tonnes



40t

D400
40 tonnes



60t

E600
60 tonnes

Applications

- Driveways
- Car parks
- Farms
- Commercial & civil areas
- Residential buildings
- Urban developments

KE 150 - Overview



Grating Options

The KE 150 channel offers a remarkable variety of 5 different grating options, allowing for customized solutions tailored to specific project requirements. These grating choices encompass a wide spectrum of designs, materials, and load-bearing capacities, ensuring adaptability to diverse applications. These grates can be crafted from materials like galvanized or stainless steel and ductile iron materials, offering exceptional resistance to corrosion, exceptional load-bearing capabilities, and enhanced aesthetic appeal.

SnapLock

SnapLock fastenings are optimised for the respective load class and combine safety and quality with functional design.

Edge Rail

Stainless or galvanized steel edge rails are seamlessly incorporated into the channel profile. Their dual role is to safeguard the channel's sidewalls against damage and minimize wear and tear, while also providing essential stability for the cover gratings. This robust steel frame is exceptionally well-suited to bear heavy traffic loads, making it an ideal choice for areas subjected to substantial wear and tear, such as freight-forwarding yards and public roadways.

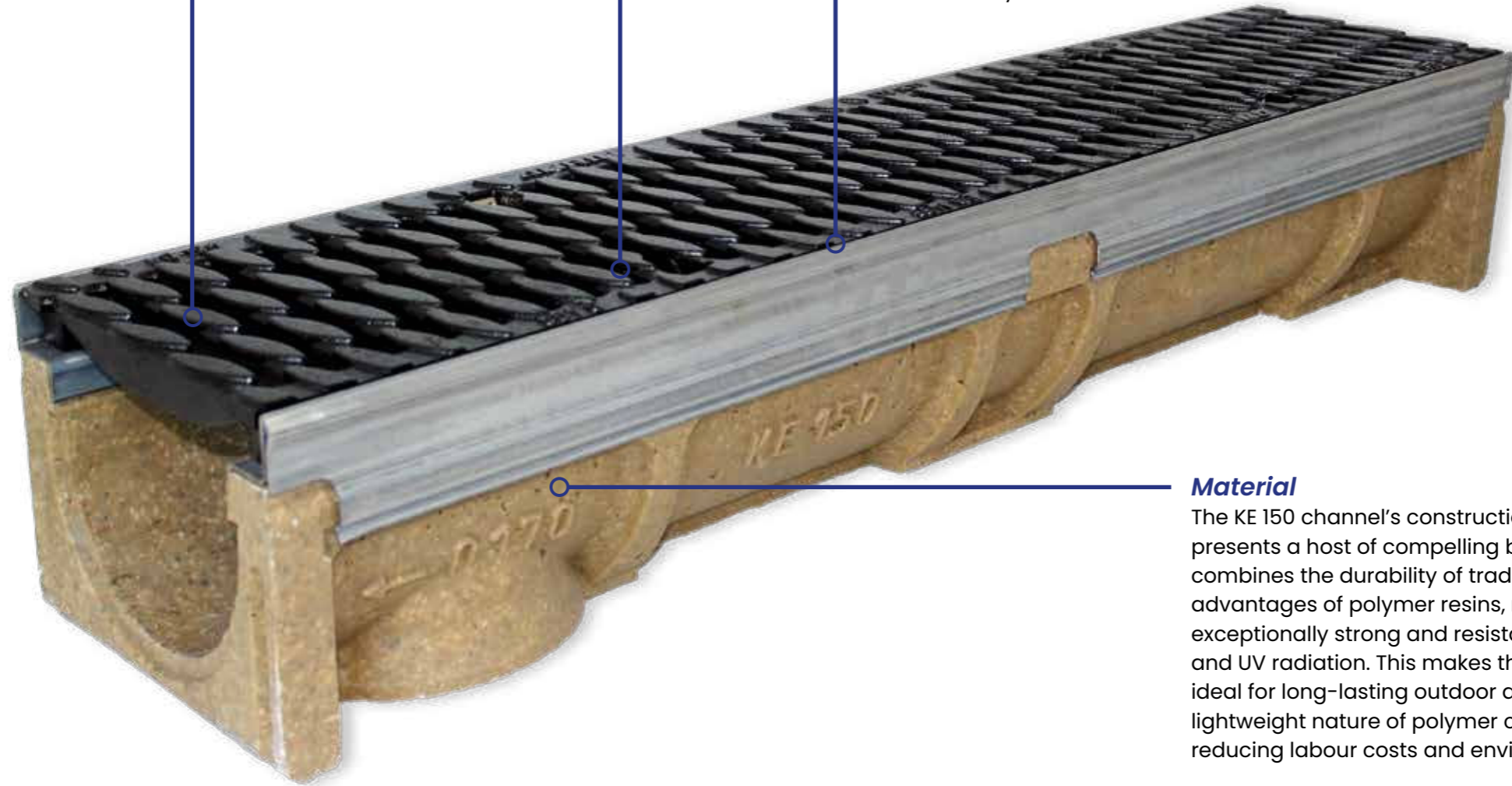

Material

The KE 150 channel's construction from polymer concrete presents a host of compelling benefits. Polymer concrete combines the durability of traditional concrete with the added advantages of polymer resins, resulting in a material that is exceptionally strong and resistant to corrosion, chemicals, and UV radiation. This makes the channel highly durable and ideal for long-lasting outdoor applications. Furthermore, the lightweight nature of polymer concrete simplifies installation, reducing labour costs and environmental impact.

Colour Options



Load Classes



A15



B125



C250



D400



E600

Depth Options



130mm



170mm



220mm

KE 150

The KE 150 channel's combination of a galvanised or stainless-steel edge rail and a polymer concrete core results in a robust and long-lasting drainage solution. Its superior durability, resistance to corrosion, and ease of installation make it a preferred choice for a wide range of construction and civil engineering projects, ensuring effective and sustainable water management.

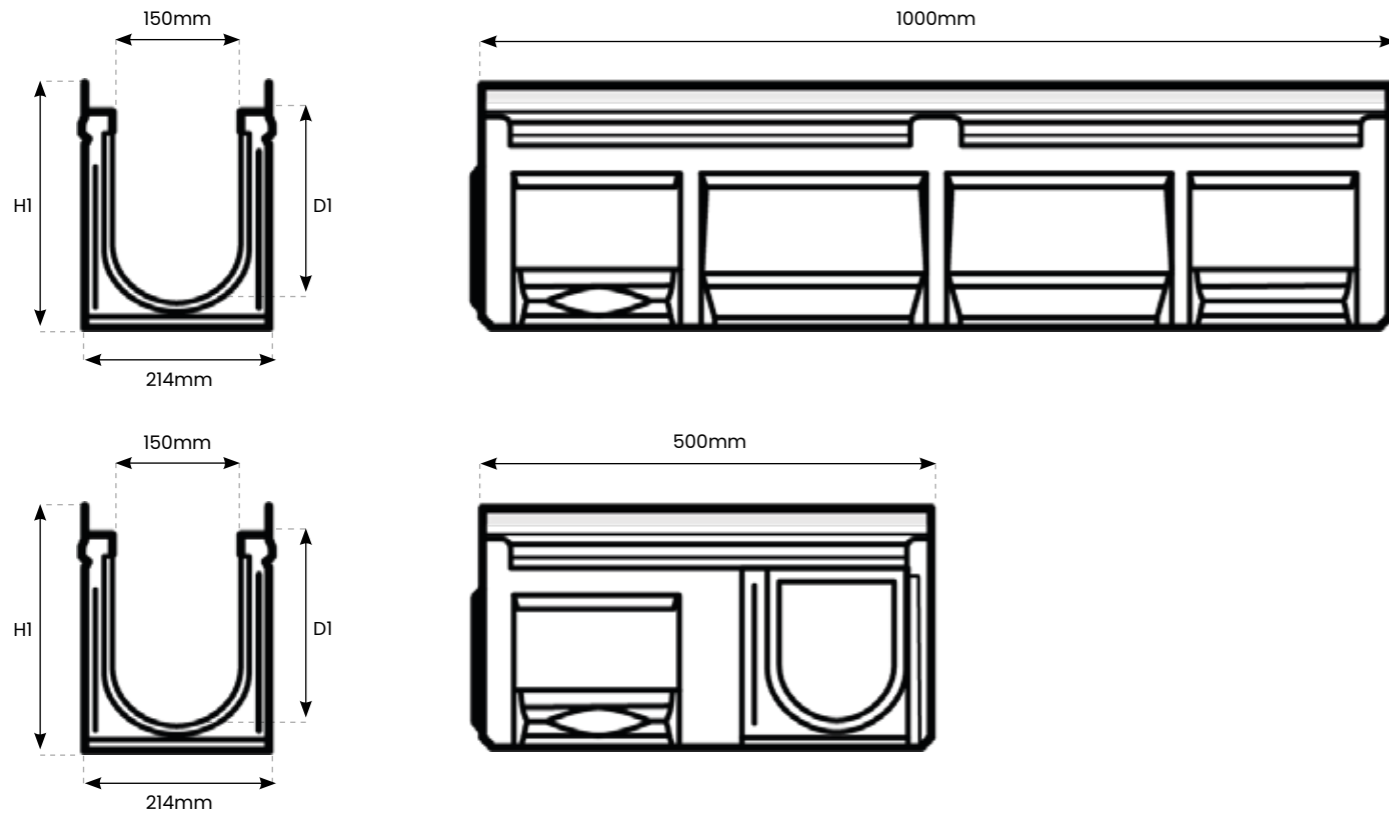

Channel Properties

Polymere concrete:	Polyester resin-based with mineral aggregates, additives.
Compressive strength:	> 90 N/mm ²
Bending tensile strength:	> 22 N/mm ²
Modulus of elasticity:	ca. 25 kN/mm ²
Density:	2.1 - 2.3 g/dm ³
Heat resistance:	100°C (permanant loading)
Frost resistance:	-50°C
Water penetration depth:	0mm
Water absorption	0.05%
Edge protection:	Galvanised steel, stainless steel, profile thickness 6mm or cataphoretic black.
Channel cover:	Galvanised steel, V2A stainless steel, GJS cast-iron, PA plastic.

Channel Types

Reference	Description	Slope	Length	Overall Width	Internal Width	Overall Depth(HI)	Internal Depth(DI)	Weight
KE.150.0	KE - 150 Channel No. 0*	0%	1000mm	214mm	150mm	220mm	200mm	33.0kg
KE.150.0R	KE - 150 Channel No. 0R***	0%	1000mm	214mm	150mm	220mm	200mm	33.0kg
KE.150.005	KE - 150 Channel No. 005**/*	0%	500mm	214mm	150mm	220mm	200mm	17.9kg
KE.150.1	KE - 150 Channel No. 1*	0.5%	1000mm	214mm	150mm	225mm	205mm	30.3kg
KE.150.2	KE - 150 Channel No. 2*	0.5%	1000mm	214mm	150mm	230mm	210mm	30.6kg
KE.150.3	KE - 150 Channel No. 3*	0.5%	1000mm	214mm	150mm	235mm	215mm	30.9kg
KE.150.4	KE - 150 Channel No. 4*	0.5%	1000mm	214mm	150mm	240mm	220mm	31.2kg
KE.150.5	KE - 150 Channel No. 5*	0.5%	1000mm	214mm	150mm	245mm	225mm	31.5kg
KE.150.6	KE - 150 Channel No. 6*	0.5%	1000mm	214mm	150mm	250mm	230mm	31.8kg
KE.150.7	KE - 150 Channel No. 7*	0.5%	1000mm	214mm	150mm	255mm	235mm	32.1kg
KE.150.8	KE - 150 Channel No. 8*	0.5%	1000mm	214mm	150mm	260mm	240mm	32.4kg
KE.150.9	KE - 150 Channel No. 9*	0.5%	1000mm	214mm	150mm	265mm	245mm	32.7kg
KE.150.10	KE - 150 Channel No. 10*	0.5%	1000mm	214mm	150mm	270mm	250mm	33.0kg
KE.150.010	KE - 150 Channel No. 010*	0%	1000mm	214mm	150mm	270mm	250mm	35.6kg
KE.150.010R	KE - 150 Channel No. 010R*	0%	1000mm	214mm	150mm	270mm	250mm	36.5kg
KE.150.0105	KE - 150 Channel No. 0105**/*	0%	500mm	214mm	150mm	270mm	250mm	19.0kg
KE.150.11	KE - 150 Channel No. 11*	0.5%	1000mm	214mm	150mm	275mm	255mm	35.5kg
KE.150.12	KE - 150 Channel No. 12*	0.5%	1000mm	214mm	150mm	280mm	260mm	35.8kg
KE.150.13	KE - 150 Channel No. 13*	0.5%	1000mm	214mm	150mm	285mm	265mm	36.1kg
KE.150.14	KE - 150 Channel No. 14*	0.5%	1000mm	214mm	150mm	290mm	270mm	36.4kg
KE.150.15	KE - 150 Channel No. 15*	0.5%	1000mm	214mm	150mm	295mm	275mm	36.7kg
KE.150.16	KE - 150 Channel No. 16*	0.5%	1000mm	214mm	150mm	300mm	280mm	37.0kg
KE.150.17	KE - 150 Channel No. 17*	0.5%	1000mm	214mm	150mm	305mm	285mm	37.3kg
KE.150.18	KE - 150 Channel No. 18*	0.5%	1000mm	214mm	150mm	310mm	290mm	37.6kg
KE.150.19	KE - 150 Channel No. 19*	0.5%	1000mm	214mm	150mm	315mm	295mm	37.9kg
KE.150.20	KE - 150 Channel No. 20*	0.5%	1000mm	214mm	150mm	320mm	300mm	38.2kg
KE.150.020	KE - 150 Channel No. 020*	0%	1000mm	214mm	150mm	320mm	300mm	38.6kg
KE.150.020R	KE - 150 Channel No. 020R***	0%	1000mm	214mm	150mm	320mm	300mm	38.6kg
KE.150.0205	KE - 150 Channel No. 0205**/*	0%	500mm	214mm	150mm	320mm	300mm	20.9kg
KE.150.150P	KE - 150 Channel No. 150P****	0%	1000mm	214mm	150mm	130mm	110mm	20.1kg
KE.150.150PR	KE - 150 Channel No. 150PR*****	0%	1000mm	214mm	150mm	130mm	110mm	20.1kg

* Channel with mouldings for vertical outlet DA/OD 110.

** Channel with sidewise perforations for the connection of t-junctions, elbow joints and cross-over joints and vertical outlet.

*** Channel with vertical pipe socket DA/OD 110.

Accessories

Sump Unit

Sump Units act as a reservoir, temporarily storing excess water before discharging it in a controlled manner to prevent adverse effects of water accumulation. The Sump Unit is excellent for collecting debris and waste that can get into the system. It comes with a silt bucket inside for easy cleaning.



Sump Unit

End Cap

End Caps can be used at the end of your channel run to stop the flow of water.



End Cap

End Cap Outlet

The End Cap Outlet can be used at the end of the run to allow water to be taken to your exterior drainage pipes and away from the channel.



End Cap Outlet

Access Tray

Access trays are typically used for maintenance and inspection purposes, they are installed at strategic points along the channel, often at intervals where they can be easily reached for cleaning, inspection, or repairs.



Access Tray

Accessories- Specifications

Reference	Description	Length	Height (H)	Overall Width	Slot Width	Weight (KG)	Outlet
KE.150.SU	KE 150 Sump Unit	500mm	594mm	214mm	-	54kg	160mm
KE.150.EC	KE 150 End Cap for channel No. 0 - 0205	30mm	130-220mm	214mm	-	1.5kg	-
KE.150.ECO	KE 150 End Cap Outlet	30mm	160mm	214mm	-	1.5kg	160mm
KE.150.AT.G	KE 150 Access Tray - Galvanised	500mm	105mm	200mm	10mm	7.2kg	-
KE.150.AT.SS	KE 150 Access Tray - Stainless Street	500mm	105mm	200mm	10mm	7.4kg	-

Grating Options



Mesh Steel Grating (D400)



Ductile Iron Longitudinal Grating (E600)



Ductile Iron Slotted Grating (E600)

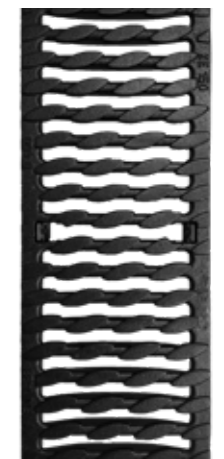

Ductile Iron Oval Grating (E600)

Grating - Specifications

Reference	Description	Lengths (mm)	Overall Width	Weight	Load Class	Safe Heel
KE.150.MSG	KE 150 Mesh Steel Grating	1000	200mm	9.8kg	C/D	No
KE.150.DILG	KE 150 Ductile Iron Longitudinal Grating	500/1000	200mm	7.8kg	D/E	No
KE.150.DISG	KE 150 Ductile Iron Slotted Grating	500	200mm	4.4kg	A/B/C/D/E	Yes
KE.150.DIOG	KE 150 Ductile Iron Oval Grating	500	200mm	7.1kg	C/D/E	No

KE 150 – Offset Single Paveslot

KE 150 Offset Paveslot is specifically designed for integration into high-quality natural stone and paving surfaces. The discrete inlet slot enables efficient drainage without compromising the ground design. We offer both single & twin slotted Paveslot as well as an access tray for cleaning purposes.

View From Above

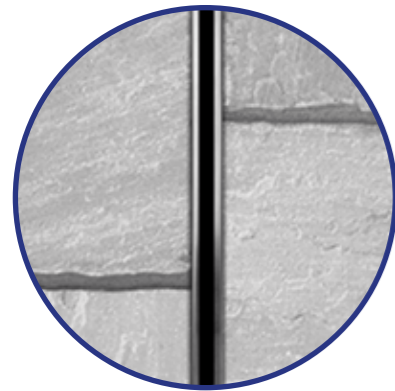

Available In Galvanised and Stainless Steel

Diagram – Offset Single Paveslot

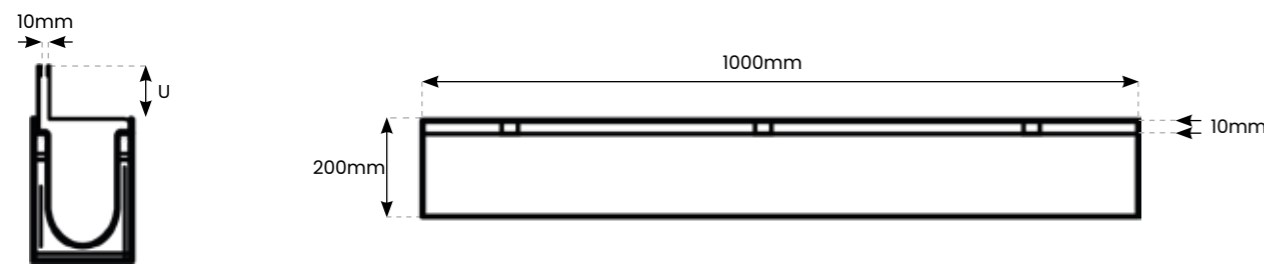

Reference	Description	Length (mm)	Slot Width	Overall Width	Load Class	Upstand (U)
OS.15060.P.G	Galvanised Offset Single Paveslot 60mm	500/1000	10mm	200mm	C/D	60mm
OS.15105.P.G	Galvanised Offset Single Paveslot 105mm	500/1000	10mm	200mm	C/D	105mm
OS.15150.P.G	Galvanised Offset Single Paveslot 150mm	500/1000	10mm	200mm	C/D	150mm
OS.15060.P.SS	Stainless Steel Offset Single Paveslot 60mm	500/1000	10mm	200mm	C/D	60mm
OS.15105.P.SS	Stainless Steel Offset Single Paveslot 105mm	500/1000	10mm	200mm	C/D	105mm
OS.15150.P.SS	Stainless Steel Offset Single Paveslot 150mm	500/1000	10mm	200mm	C/D	150mm

KE 150 – Offset Twin Paveslot

KE 150 Offset Paveslot is specifically designed for integration into high-quality natural stone and paving surfaces. The discrete inlet slot enables efficient drainage without compromising the ground design. We offer both single & twin slotted Paveslot as well as an access tray for cleaning purposes.

View From Above

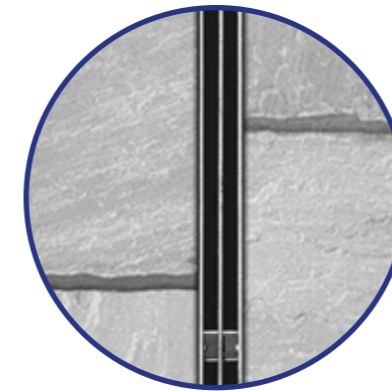

Available In Galvanised and Stainless Steel

Diagram – Offset Twin Paveslot

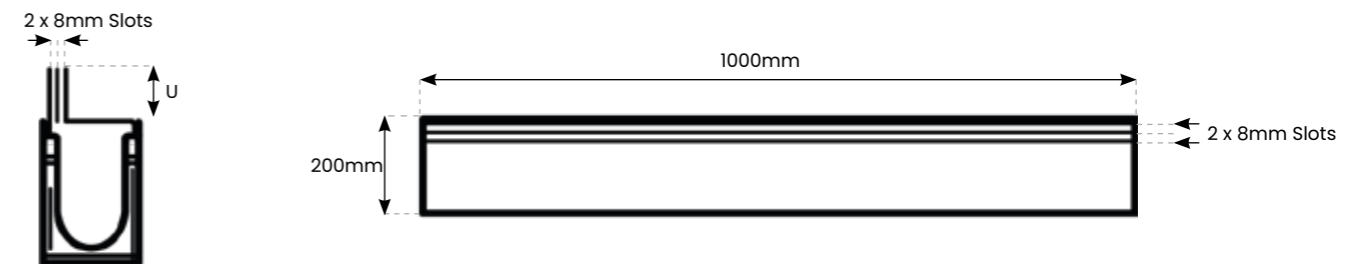

Reference	Description	Length (mm)	Slot Width	Overall Width	Load Class	Upstand (U)
OT.15060.P.G	Galvanised Offset Twin Paveslot 60mm	500/1000	2x8mm	200mm	C/D	60mm
OT.15105.P.G	Galvanised Offset Twin Paveslot 105mm	500/1000	2x8mm	200mm	C/D	105mm
OT.15150.P.G	Galvanised Offset Twin Paveslot 150mm	500/1000	2x8mm	200mm	C/D	150mm
OT.15060.P.SS	Stainless Steel Offset Twin Paveslot 60mm	500/1000	2x8mm	200mm	C/D	60mm
OT.15105.P.SS	Stainless Steel Offset Twin Paveslot 105mm	500/1000	2x8mm	200mm	C/D	105mm
OT.15150.P.SS	Stainless Steel Offset Twin Paveslot 150mm	500/1000	2x8mm	200mm	C/D	150mm

KE 150 – Centre Single Paveslot

KE 150 Centre Paveslot is specifically designed for integration into high-quality natural stone and paving surfaces. The discrete inlet slot enables efficient drainage without compromising the ground design. We offer both single & twin slotted Paveslot as well as an access tray for cleaning purposes.

View From Above

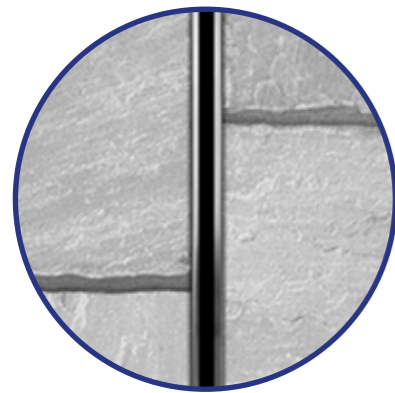

Available In Galvanised and Stainless Steel

Diagram – Centre Single Paveslot

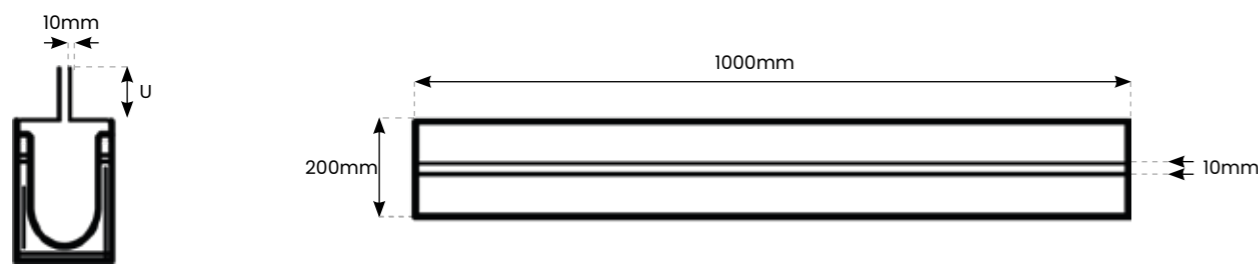

KE 150 – Centre Twin Paveslot

KE 150 Centre Paveslot is specifically designed for integration into high-quality natural stone and paving surfaces. The discrete inlet slot enables efficient drainage without compromising the ground design. We offer both single & twin slotted Paveslot as well as an access tray for cleaning purposes.

View From Above

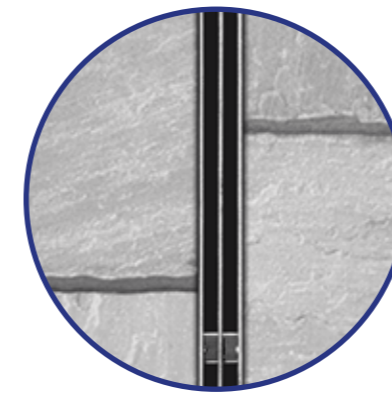

Available In Galvanised and Stainless Steel

Diagram – Centre Twin Paveslot

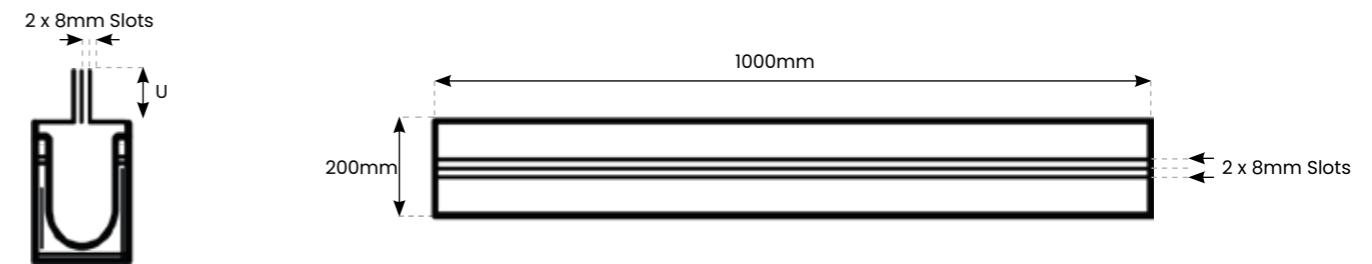

Reference	Description	Length (mm)	Slot Width	Overall Width	Load Class	Upstand (U)
CS.15060.P.G	Galvanised Centre Single Paveslot 60mm	500/1000	10mm	200mm	C/D	60mm
CS.15105.P.G	Galvanised Centre Single Paveslot 105mm	500/1000	10mm	200mm	C/D	105mm
CS.15150.P.G	Galvanised Centre Single Paveslot 150mm	500/1000	10mm	200mm	C/D	150mm
CS.15060.P.SS	Stainless Steel Centre Single Paveslot 60mm	500/1000	10mm	200mm	C/D	60mm
CS.15105.P.SS	Stainless Steel Centre Single Paveslot 105mm	500/1000	10mm	200mm	C/D	105mm
CS.15150.P.SS	Stainless Steel Centre Single Paveslot 150mm	500/1000	10mm	200mm	C/D	150mm

Reference	Description	Length (mm)	Slot Width	Overall Width	Load Class	Upstand (U)
CT.15060.P.G	Galvanised Centre Twin Paveslot 60mm	500/1000	2x8mm	200mm	C/D	60mm
CT.15105.P.G	Galvanised Centre Twin Paveslot 105mm	500/1000	2x8mm	200mm	C/D	105mm
CT.15150.P.G	Galvanised Centre Twin Paveslot 150mm	500/1000	2x8mm	200mm	C/D	150mm
CT.15060.P.SS	Stainless Steel Centre Twin Paveslot 60mm	500/1000	2x8mm	200mm	C/D	60mm
CT.15105.P.SS	Stainless Steel Centre Twin Paveslot 105mm	500/1000	2x8mm	200mm	C/D	105mm
CT.15150.P.SS	Stainless Steel Centre Twin Paveslot 150mm	500/1000	2x8mm	200mm	C/D	150mm



KE 200

The KE 200 channel is a versatile and innovative drainage solution that offers a multitude of advantages in construction and civil engineering projects. At the heart of its design lies the exceptional combination of a galvanized or stainless-steel edge rail and a core made from polymer concrete. This unique blend of materials results in a drainage channel that not only excels in durability but also offers a range of practical benefits that make it a popular choice for a wide array of applications.

The incorporation of galvanized or stainless-steel edge rails within the KE 200 channel is a standout feature. This steel component enhances the product's strength and longevity, ensuring that it can withstand traffic loads and harsh environmental conditions.

The corrosion-resistant properties of these materials make the KE 200 channel an excellent choice for projects where extended service life and minimal maintenance are essential. Furthermore, the steel edge rail provides crucial structural support to the entire drainage system, preventing deformation and ensuring efficient water conveyance.

The core of the KE 200 channel is constructed from polymer concrete, which offers several advantages in terms of durability and performance. This material is highly resistant to chemical and physical wear, making it an ideal choice for applications in industrial and commercial settings where exposure to corrosive substances is a concern. Additionally, the polymer concrete core is lightweight, facilitating easier handling and installation, while also promoting a reduction in transportation costs.

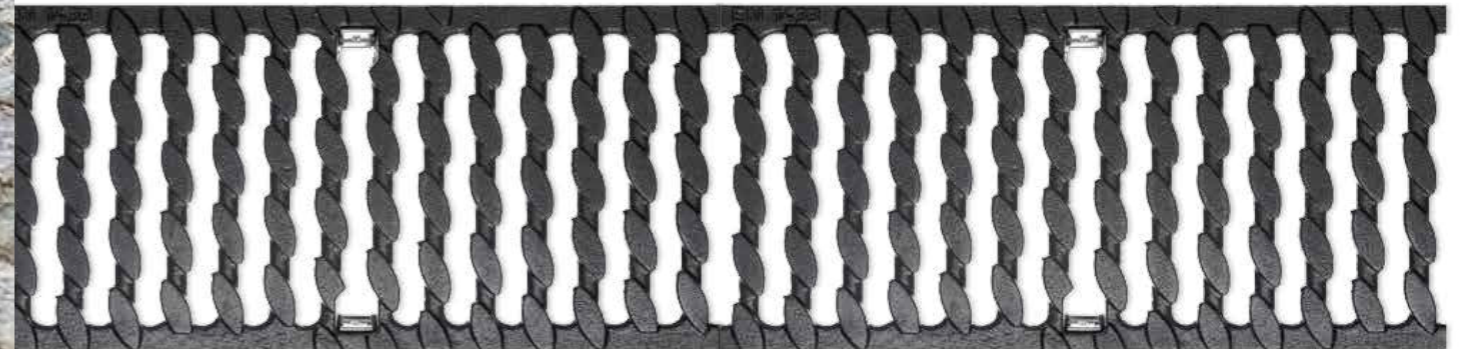

Load Class

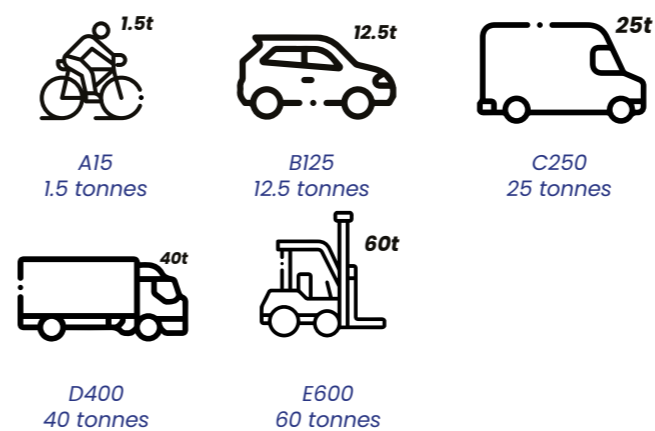

Applications

- Driveways
- Car parks
- Farms
- Commercial & civil areas
- Residential buildings
- Urban developments

KE 200 - Overview



Grating Options

The KE 200 channel offers a remarkable variety of 4 different grating options, allowing for customized solutions tailored to specific project requirements. These grating choices encompass a wide spectrum of designs, materials, and load-bearing capacities, ensuring adaptability to diverse applications. These grates can be crafted from materials like galvanized or stainless steel and ductile iron materials, offering exceptional resistance to corrosion, exceptional load-bearing capabilities, and enhanced aesthetic appeal.

SnapLock

SnapLock fastenings are optimised for the respective load class and combine safety and quality with functional design.

Edge Rail

Stainless or galvanized steel edge rails are seamlessly incorporated into the channel profile. Their dual role is to safeguard the channel's sidewalls against damage and minimize wear and tear, while also providing essential stability for the cover gratings. This robust steel frame is exceptionally well-suited to bear heavy traffic loads, making it an ideal choice for areas subjected to substantial wear and tear, such as freight-forwarding yards and public roadways.

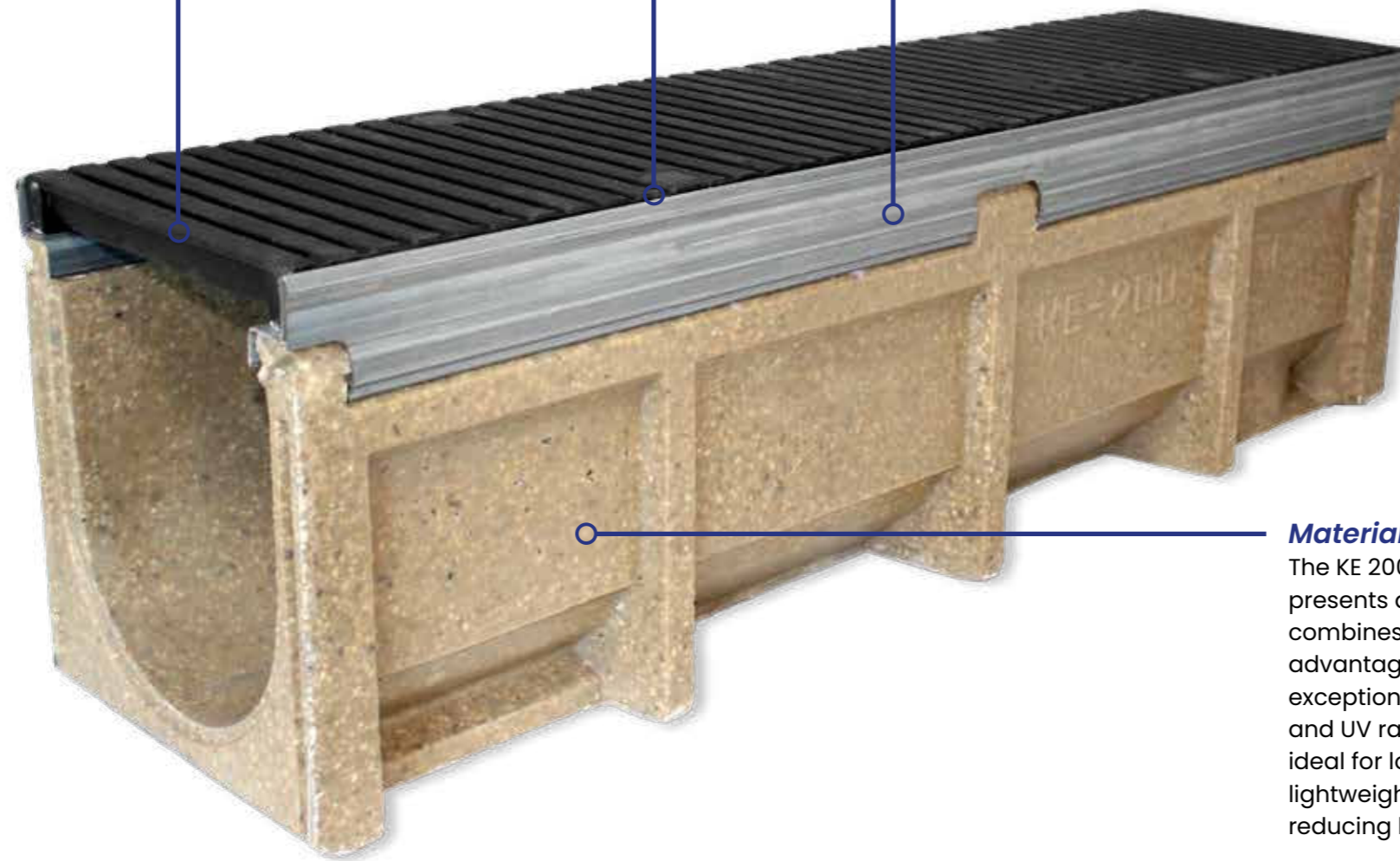

Material

The KE 200 channel's construction from polymer concrete presents a host of compelling benefits. Polymer concrete combines the durability of traditional concrete with the added advantages of polymer resins, resulting in a material that is exceptionally strong and resistant to corrosion, chemicals, and UV radiation. This makes the channel highly durable and ideal for long-lasting outdoor applications. Furthermore, the lightweight nature of polymer concrete simplifies installation, reducing labour costs and environmental impact.

Colour Options

Sand



Load Classes



A15



B125



C250



D400



E600

Depth Options



130mm



290mm

KE 200

The KE 200 channel's combination of a galvanised or stainless-steel edge rail and a polymer concrete core results in a robust and long-lasting drainage solution. Its superior durability, resistance to corrosion, and ease of installation make it a preferred choice for a wide range of construction and civil engineering projects, ensuring effective and sustainable water management.

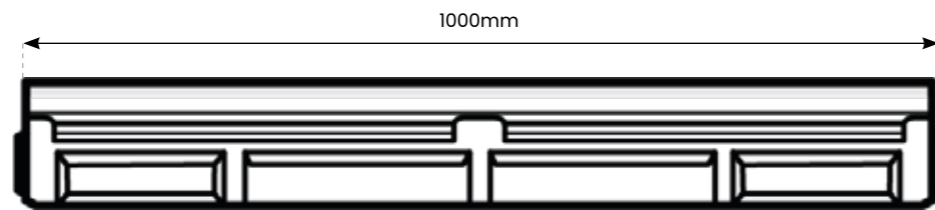
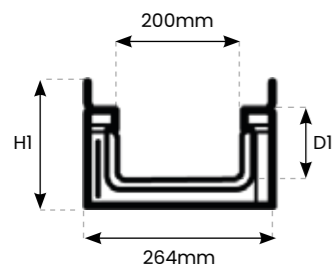
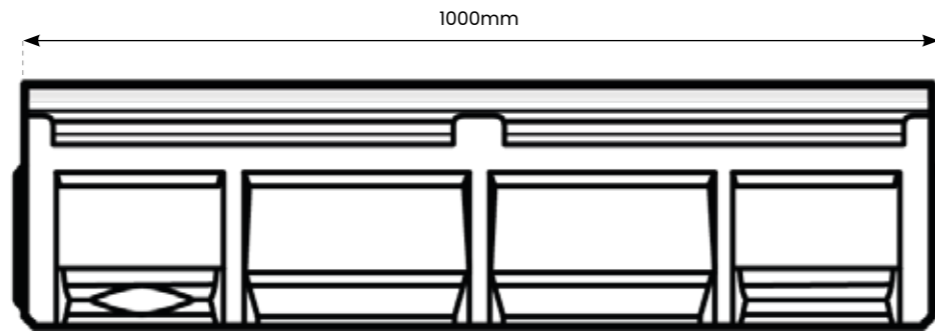
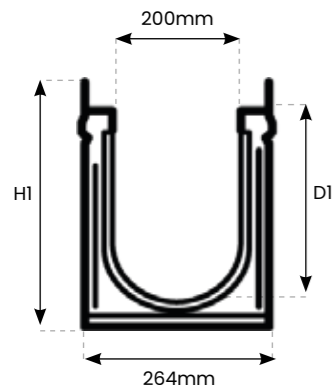

Channel Properties

Polymer concrete:	Polyester resin-based with mineral aggregates, additives.
Compressive strength:	> 90 N/mm²
Bending tensile strength:	> 22 N/mm²
Modulus of elasticity:	ca. 25 kN/mm²
Density:	2.1 - 2.3 g/dm³
Heat resistance:	100°C (permenant loading)
Frost resistance:	-50°C
Water penetration depth:	0mm
Water absorption:	0.05%
Edge protection:	Galvanised steel, stainless steel, profile thickness 6mm or cataphoretic black.
Channel cover:	Galvanised steel, V2A stainless steel, GJS cast-iron, PA plastic.

Channel Types

Reference	Description	Slope	Length	Overall Width	Internal Width	Overall Depth(HI)	Internal Depth(D1)	Weight
KE.200.0	KE - 200 Channel No. 0*	0%	1000mm	264mm	200mm	290mm	270mm	43.0kg
KE.200.0R	KE - 200 Channel No. 0R***	0%	1000mm	264mm	200mm	290mm	270mm	43.0kg
KE.200.200P	KE - 200 Channel No. 200P****	0%	1000mm	264mm	200mm	130mm	110mm	22.2kg
KE.200.200PR	KE - 200 Channel No. 200PR*****	0%	1000mm	264mm	200mm	130mm	110mm	22.2kg

* Channel with mouldings for vertical outlet DA/OD 160

** Channel with sidewise perforations for the connection of t-junctions, elbow joints and cross-over joints and vertical outlet

*** Channel with vertical pipe socket DA/OD 160

**** Channel with mouldings for vertical outlet DA/OD 110

***** Channel with vertical pipe socket DA/OD 110

Channel tolerances + / - 10mm

Channel available in both Galvanised Steel or Stainless Steel

Accessories

Sump Unit

Sump Units act as a reservoir, temporarily storing excess water before discharging it in a controlled manner to prevent adverse effects of water accumulation. The Sump Unit is excellent for collecting debris and waste that can get into the system. It comes with a silt bucket inside for easy cleaning.



Sump Unit

End Cap

End Caps can be used at the end of your channel run to stop the flow of water.



End Cap

End Cap Outlet

The End Cap Outlet can be used at the end of the run to allow water to be taken to your exterior drainage pipes and away from the channel.



End Cap Outlet

Access Tray

Access trays are typically used for maintenance and inspection purposes, they are installed at strategic points along the channel, often at intervals where they can be easily reached for cleaning, inspection, or repairs.



Access Tray

Accessories- Specifications

Reference	Description	Length	Height (H)	Overall Width	Slot Width	Weight (KG)	Outlet
KE.200.SU	KE 200 Sump Unit	500mm	700mm	264mm	-	54kg	160mm
KE.200.EC	KE 200 End Cap	30mm	130-290mm	264mm	-	1.5kg	-
KE.200.ECO	KE 200 End Cap Outlet	30mm	130-290mm	264mm	-	1.5kg	160mm
KE.200.AT.G	KE 200 Access Tray - Galvanised	500mm	105mm	250mm	10mm	7.2kg	-
KE.200.AT.SS	KE 200 Access Tray - Stainless Street	500mm	105mm	250mm	10mm	7.4kg	-

Grating Options



Mesh Steel Grating (D400)



Ductile Iron Slotted Grating (E600)



Ductile Iron Oval Grating (E600)

Grating - Specifications

Reference	Description	Lengths (mm)	Overall Width	Weight	Load Class	Safe Heel
KE.200.MSG	KE 200 Mesh Steel Grating	1000	250mm	10.8kg	C/D	No
KE.200.DISG	KE 200 Ductile Iron Slotted Grating	500	250mm	11.5kg	A/B/C/D/E	Yes
KE.200.DIOG	KE 200 Ductile Iron Oval Grating	500	250mm	11.9kg	C/D/E	No

KE 200 – Offset Single Paveslot

KE 200 Offset Paveslot is specifically designed for integration into high-quality natural stone and paving surfaces. The discrete inlet slot enables efficient drainage without compromising the ground design. We offer both single & twin slotted Paveslot as well as an access tray for cleaning purposes.

View From Above

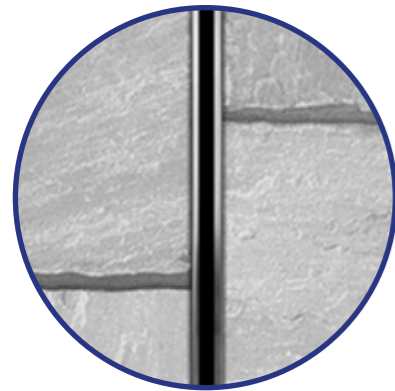

Available In Galvanised and Stainless Steel

Diagram – Offset Single Paveslot

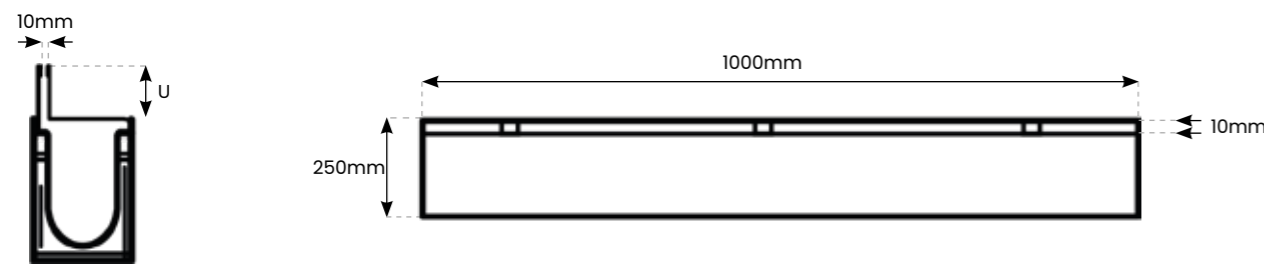

Reference	Description	Length (mm)	Slot Width	Overall Width	Load Class	Upstand (U)
OS.20060.P.G	Galvanised Offset Single Paveslot 60mm	1000	10mm	250mm	C/D	60mm
OS.20105.P.G	Galvanised Offset Single Paveslot 105mm	1000	10mm	250mm	C/D	105mm
OS.20150.P.G	Galvanised Offset Single Paveslot 150mm	1000	10mm	250mm	C/D	150mm
OS.20060.P.SS	Stainless Steel Offset Single Paveslot 60mm	1000	10mm	250mm	C/D	60mm
OS.20105.P.SS	Stainless Steel Offset Single Paveslot 105mm	1000	10mm	250mm	C/D	105mm
OS.20150.P.SS	Stainless Steel Offset Single Paveslot 150mm	1000	10mm	250mm	C/D	150mm

KE 200 – Offset Twin Paveslot

KE 200 Offset Paveslot is specifically designed for integration into high-quality natural stone and paving surfaces. The discrete inlet slot enables efficient drainage without compromising the ground design. We offer both single & twin slotted Paveslot as well as an access tray for cleaning purposes.

View From Above

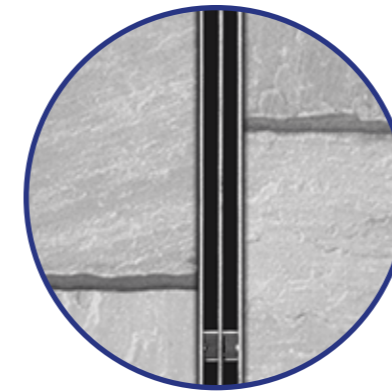

Available In Galvanised and Stainless Steel

Diagram – Offset Twin Paveslot

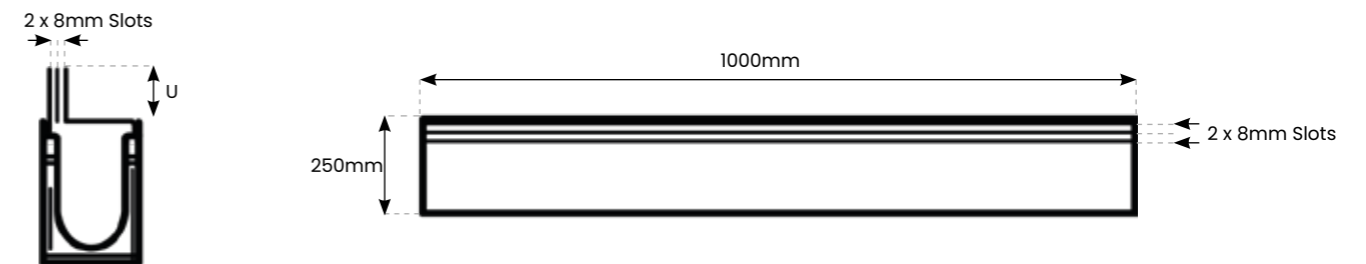

Reference	Description	Length (mm)	Slot Width	Overall Width	Load Class	Upstand (U)
OT.20060.P.G	Galvanised Offset Twin Paveslot 60mm	1000	2x8mm	250mm	C/D	60mm
OT.20105.P.G	Galvanised Offset Twin Paveslot 105mm	1000	2x8mm	250mm	C/D	105mm
OT.20150.P.G	Galvanised Offset Twin Paveslot 150mm	1000	2x8mm	250mm	C/D	150mm
OT.20060.P.SS	Stainless Steel Offset Twin Paveslot 60mm	1000	2x8mm	250mm	C/D	60mm
OT.20105.P.SS	Stainless Steel Offset Twin Paveslot 105mm	1000	2x8mm	250mm	C/D	105mm
OT.20150.P.SS	Stainless Steel Offset Twin Paveslot 150mm	1000	2x8mm	250mm	C/D	150mm

KE 200 – Centre Single Paveslot

KE 200 Centre Paveslot is specifically designed for integration into high-quality natural stone and paving surfaces. The discrete inlet slot enables efficient drainage without compromising the ground design. We offer both single & twin slotted Paveslot as well as an access tray for cleaning purposes.

View From Above

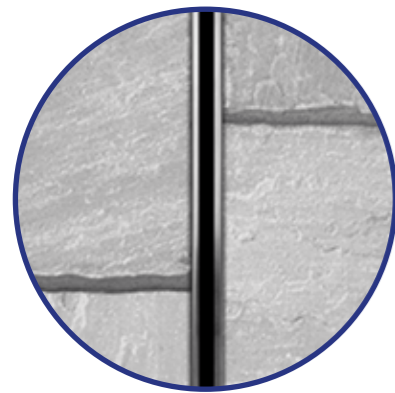

Available In Galvanised and Stainless Steel

Diagram – Centre Single Paveslot

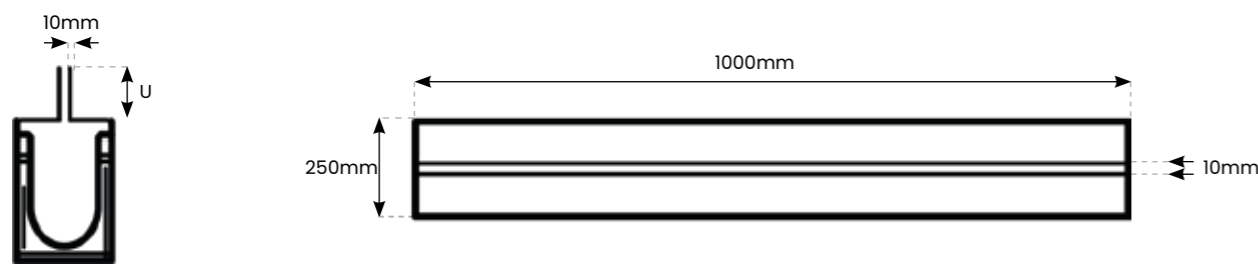

KE 200 – Centre Twin Paveslot

KE 200 Centre Paveslot is specifically designed for integration into high-quality natural stone and paving surfaces. The discrete inlet slot enables efficient drainage without compromising the ground design. We offer both single & twin slotted Paveslot as well as an access tray for cleaning purposes.

View From Above

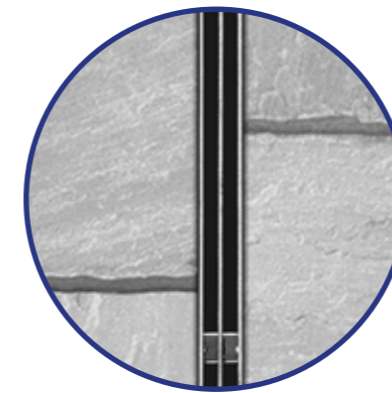

Available In Galvanised and Stainless Steel

Diagram – Centre Twin Paveslot

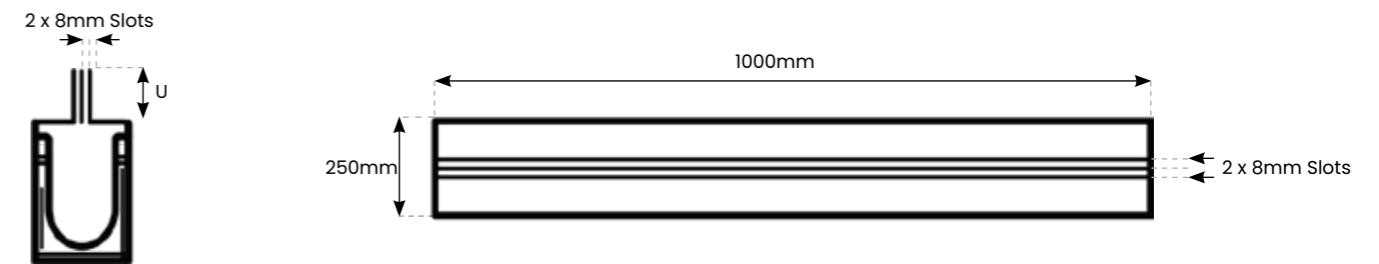

Reference	Description	Length (mm)	Slot Width	Overall Width	Load Class	Upstand (U)
CS.20060.P.G	Galvanised Centre Single Paveslot 60mm	1000	10mm	250mm	C/D	60mm
CS.20105.P.G	Galvanised Centre Single Paveslot 105mm	1000	10mm	250mm	C/D	105mm
CS.20150.P.G	Galvanised Centre Single Paveslot 150mm	1000	10mm	250mm	C/D	150mm
CS.20060.P.SS	Stainless Steel Centre Single Paveslot 60mm	1000	10mm	250mm	C/D	60mm
CS.20105.P.SS	Stainless Steel Centre Single Paveslot 105mm	1000	10mm	250mm	C/D	105mm
CS.20150.P.SS	Stainless Steel Centre Single Paveslot 150mm	1000	10mm	250mm	C/D	150mm

Reference	Description	Length (mm)	Slot Width	Overall Width	Load Class	Upstand (U)
CT.20060.P.G	Galvanised Centre Twin Paveslot 60mm	1000	2x8mm	250mm	C/D	60mm
CT.20105.P.G	Galvanised Centre Twin Paveslot 105mm	1000	2x8mm	250mm	C/D	105mm
CT.20150.P.G	Galvanised Centre Twin Paveslot 150mm	1000	2x8mm	250mm	C/D	150mm
CT.20060.P.SS	Stainless Steel Centre Twin Paveslot 60mm	1000	2x8mm	250mm	C/D	60mm
CT.20105.P.SS	Stainless Steel Centre Twin Paveslot 105mm	1000	2x8mm	250mm	C/D	105mm
CT.20150.P.SS	Stainless Steel Centre Twin Paveslot 150mm	1000	2x8mm	250mm	C/D	150mm

Sloped, Stepped, Level

There are 3 different scenarios in which the KE drainage channel can be installed. However, the purpose of all 3 of these variations is to provide a pathway for the removal of unwanted surface water in a selected area. The specifics of which channel should be used are dependent on multiple factors such as the terrain, flow rate, and other environmental conditions.

Sloped Invert

A channel run with a sloped invert has a consistent downward gradient along its length. The slope is designed to provide a continuous downward flow of water, allowing gravity to assist in the drainage of water. When using a sloped channel it is carefully calculated to ensure that the water will flow at an appropriate velocity to prevent sedimentation or excessive erosion.

Sloped Invert

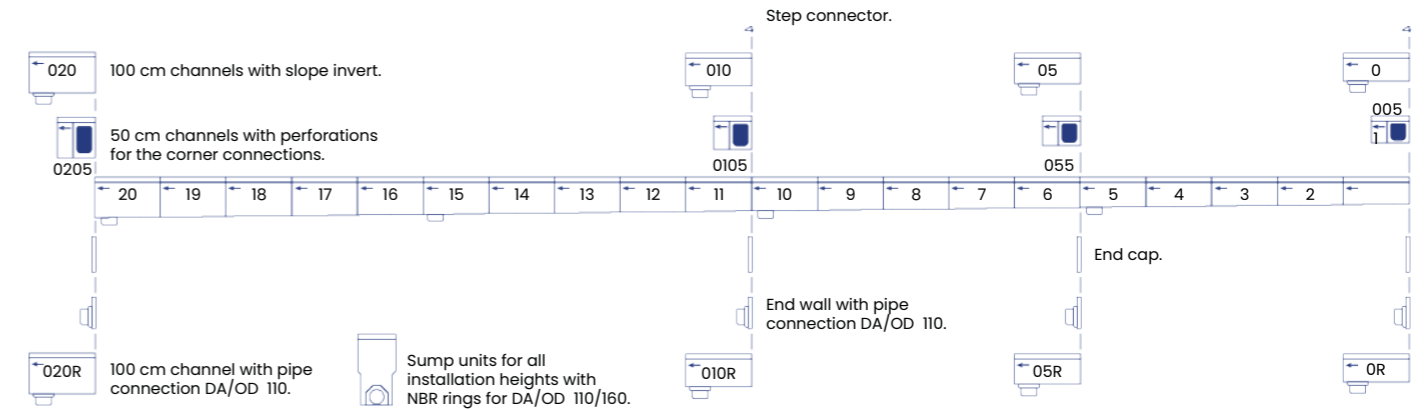

Stepped Invert

Stepped drainage channels are designed with a series of steps or drops along the run of the channel. These steps create a cascading effect, which helps to control the velocity of the water and prevent erosion.

Stepped Invert

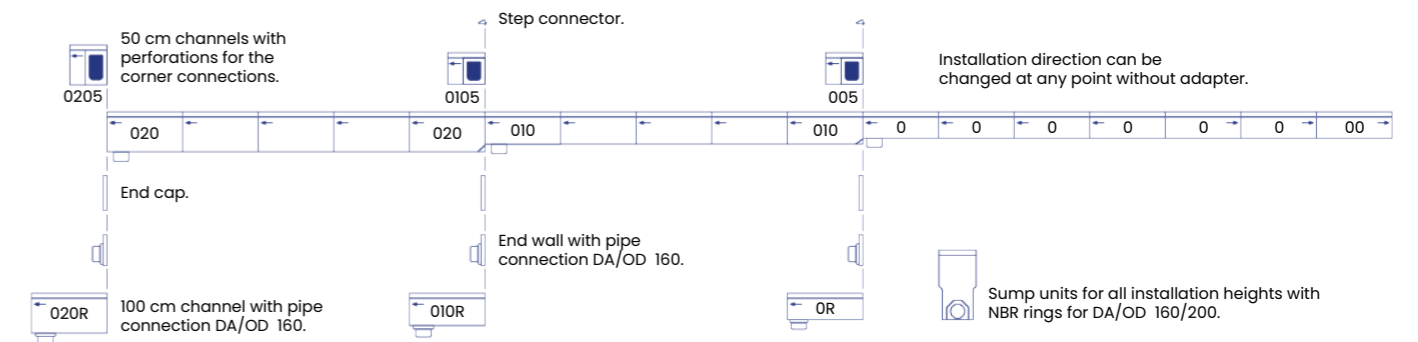

Level Invert

Level inverts are usually used in areas with relatively low slopes or insignificant water rates. They allow water to flow smoothly and evenly without the need for any significant changes in elevation. Channels with a level invert are often used in urban areas, where the goal is to transport water efficiently and prevent flooding.

Level Invert

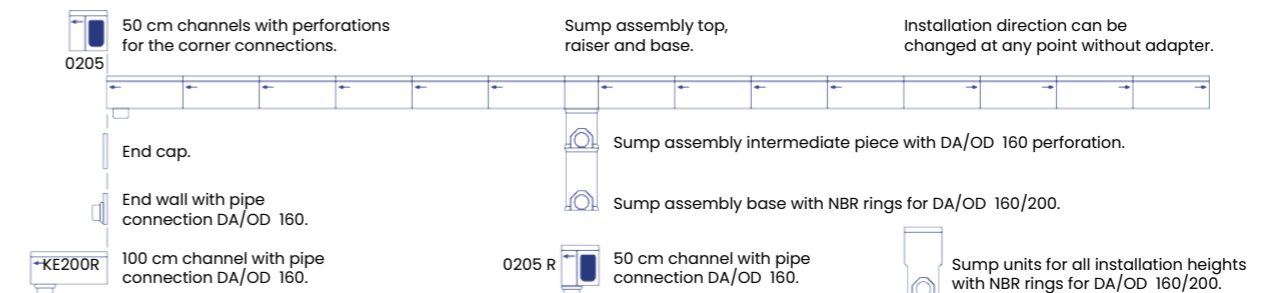



Polycon Surface Water Drainage

**Widnes Business Park
Foundry Lane
Widnes
Cheshire
WA8 8UB**

**www.polycon.co.uk
0151 422 9747
sales@polycon.co.uk**

Service . Range . Knowledge